

Verona 4 Drawer Chest Wall Attachment Instructions

Pre-assembly Preparation

Please read these instructions fully prior to assembly to familiarise yourself with the various stages of construction. Carefully open all packs supplied and check the contents against the parts and fittings check list.

Do not destroy any of the packaging until you are certain that you have all the necessary parts for the assembly.

This item is heavy once assembled. Please try to assemble the item as close as possible to the point of use. Take care when moving the item to avoid personal injury or damage to the product and always lift rather than drag.

There are small components used in the construction of this furniture as well as plastic foil packaging, these should be kept away from young children whilst assembling.

This product requires a minimum of 2 people to assemble.

Product Safety

All assembly fastenings should always be tightened properly and care should be taken to ensure that no fittings are loose.

Periodically check and ensure that all components are in their proper position, free from damage, and that all connectors are tight.

Product Care

To clean, slightly moisten cloth with water and wipe surfaces. A damp cloth holds dust and prevents damage. repeat with a dry, soft, lint-free cloth.

Do not use abrasives or cleaning products which may contain ammonia or solvents

Tools Required:

Please use a Phillips Screwdriver (not included)



If you require any advice during assembly please call our customer service team on 01243 380600.

Verona 4 Drawer Chest Wall Attachment Instructions

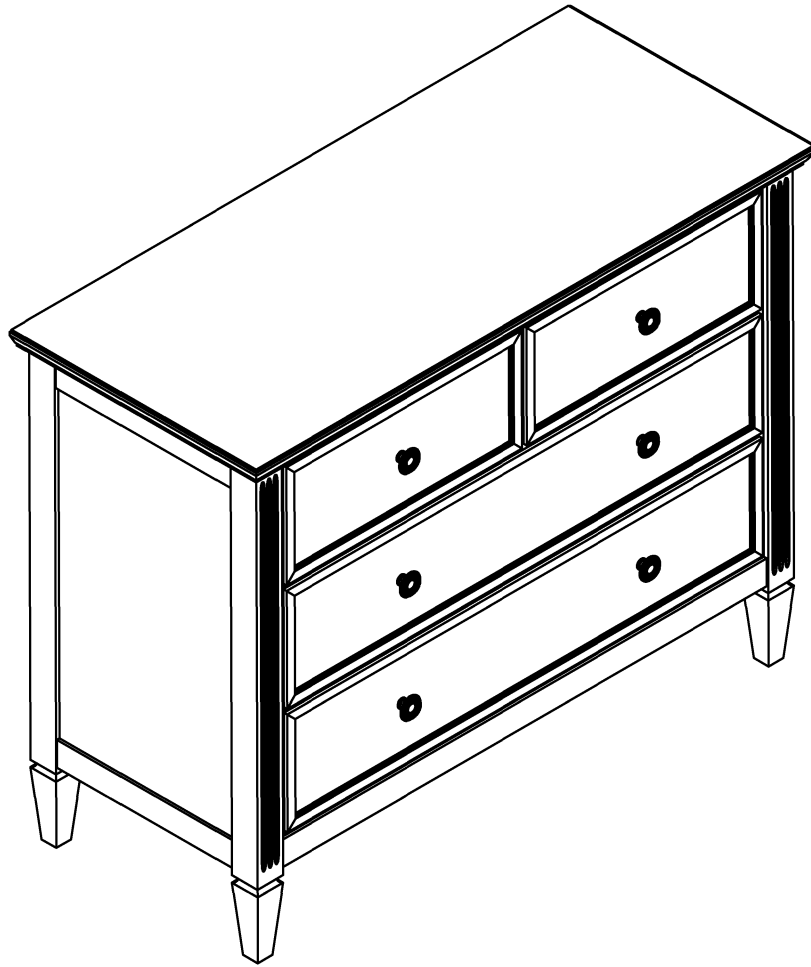

Hardware and Wall Fixing Packs

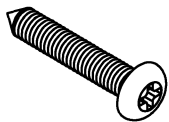

Strap Fixing Screw

(A) = 1 pc



Strap Fixing Washer

(B) = 1 pc



Strap

(C) = 1 pc

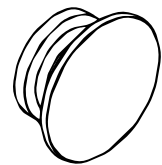

Optional Painted Handle

6 pcs

Verona 4 Drawer Chest Wall Attachment Instructions

1

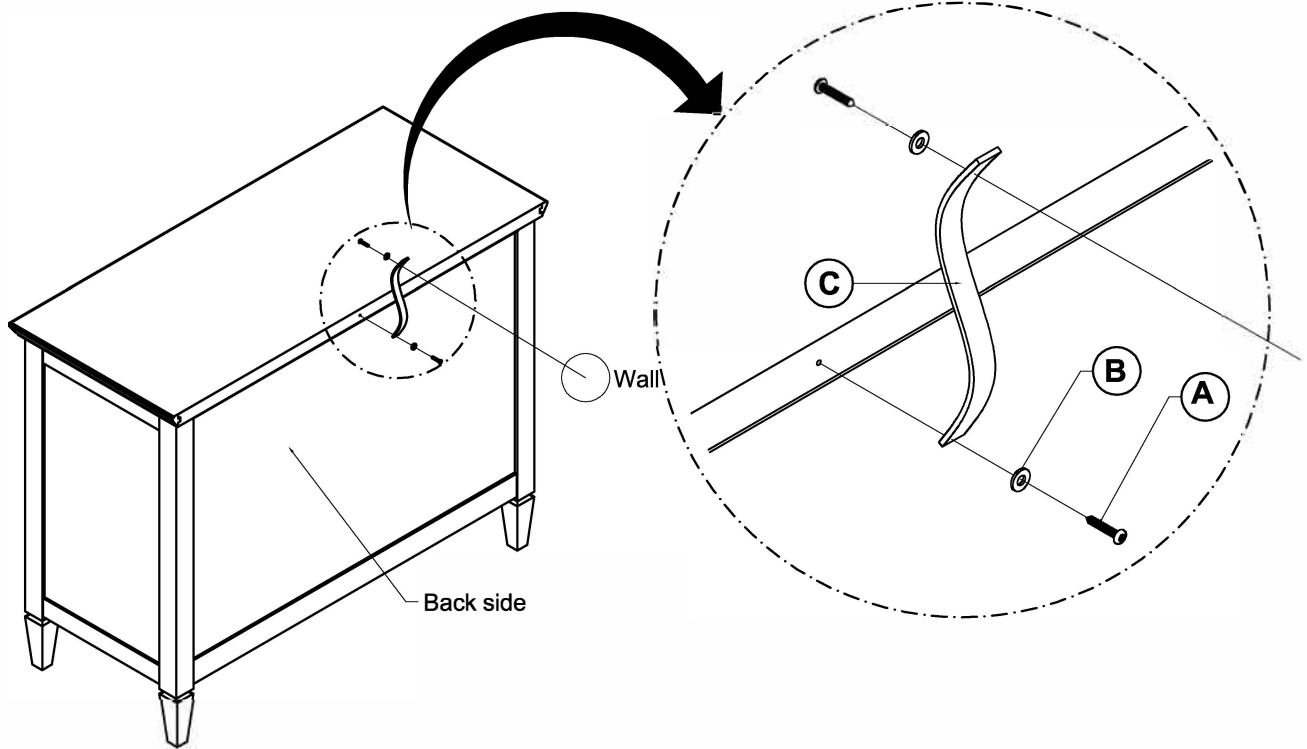

To avoid any risk of tipping, it is recommended to secure this unit to the wall as below instruction guide
Due to different wall types, fixing NOT included

Wall Fixing - if in doubt seek professional advice

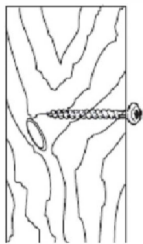

Wood

If fixing to wood make sure that it isn't chipboard as screws can easily pull away from the core structure

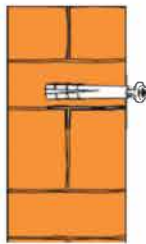

Brick or Masonry

Use an appropriate wall plug provided you are sure your wall is sound

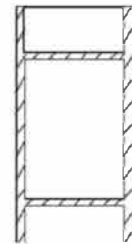

Cavity Wall

Special toggle wall plugs are needed. Seek expert advice